

IMPORTANT: Read before using



Operating/Safety Instructions

Tool Change Attachment for HF350 / HF500



Call for consumer information

Customers from outside the U.S.

STEPCRAFT GmbH & Co. KG
An der Beile 2
58708 Menden
Germany
Phone: 0049-2373-179 11 60
E-Mail: info@stepcraft-systems.com

Customers from the U.S. / Canada

STEPCRAFT Inc.
733 E Main St. Unit 3
Torrington, CT, 06790
United States
Phone 001-203-5561856
E-mail info@stepcraft.us

Original Operating/Safety Instructions

Date of: 07-25-2016

NOTICE

All instructions, warranties and other collateral documents are subject to change at the sole discretion of STEPCRAFT, Inc. For up-to date product literature, visit www.stepcraft-systems.com for customers from Europe or www.stepcraft.us for customers from US / Canada and click on the service & support tab for this product.

Meaning of Special Language

The following terms are used throughout the product literature to indicate various levels of potential harm when operating this product: The purpose of safety symbols is to attract your attention to possible dangers. The safety symbols, and their explanations, deserve your careful attention and understanding. The safety warnings themselves do not eliminate any danger. The instructions or warnings they give are not substitutes for proper accident prevention measures.

NOTICE Procedures, which if not properly followed, create a possibility of physical property damage AND a little or no possibility of injury.

CAUTION Procedures, which if not properly followed, create a probability of physical property damage AND a possibility of serious injury.

WARNING Procedures, which if not properly followed, create a probability of property damage, collateral damage, serious injury or death OR create a high probability of superficial injury.



Safety Alert: Indicates caution or warning. Attention is required in order to avoid serious personal injury.



Read the ENTIRE instruction manual in order to become familiar with the features of the product and how to operate them. Failure to operate the product correctly can result in damage to the product, personal property and cause serious injury, electric shock and/or fire.

This is a sophisticated hobby and semi-professional product for advanced craftsmen with previous experience in the operation of tools such as electric drills, routers and computerized tools like CNC routers or 3D printers. It must be operated with caution and common sense and requires some basic mechanical ability. Failure to operate this product in a safe and responsible manner could result in personal injury or damage to the product or other property. This product is not intended for use by children without direct adult supervision. Do not attempt disassembly, use with incompatible components or augment product in any way without the approval of STEPCRAFT GmbH & Co. KG or STEPCRAFT, Inc. This manual contains instructions for safety, operation and maintenance. It is essential to read and follow all the instructions and warnings in the manual, prior to assembly, setup or use, in order to operate correctly and avoid damage or serious injury.

Age Recommendation: For advanced handcrafters ages 14 and above. This is not a toy.

SAVE ALL WARNINGS AND INSTRUCTIONS FOR FUTURE REFERENCE.

Should you encounter any doubts or require any further information, please do not hesitate to contact us before commissioning of the power tool. Our contact details can be found on the front page of this manual.

The term "power tool" in the warnings refers to your mains-operated (corded) power supply and the STEPCRAFT High frequency (HFS) in connection with the Tool Change Attachment.

General Power Tool Safety Warnings

Work area safety

	Keep work area clean and well lit. Cluttered or dark areas invite accidents.
CAUTION	Do not operate power tools in explosive atmospheres, such as in the presence of flammable liquids, gases or dust. Power tools create sparks which may ignite the dust or fumes.
NOTICE	Keep children and bystanders away while operating a power tool. Distractions can cause you to lose control and can result in accidents.

Continued on next page

Electrical safety

⚠ WARNING	<p>Power tool plugs must match the outlet. Never modify the plug in any way. Do not use any adapter plugs with earthed (grounded) power tools. Unmodified plugs and matching outlets will reduce the risk of electric shock.</p> <p>Avoid body contact with earthed or grounded surfaces such as pipes, radiators, ranges and refrigerators. There is an increased risk of electric shock if your body is earthed or grounded.</p> <p>Do not expose power tools to rain or wet conditions. The spindle is only suitable for indoor use. Water entering a power tool will increase the risk of electric shock.</p> <p>Do not misuse the cord. Never use the cord for carrying, pulling or unplugging the power tool. Keep cord away from heat, oil, sharp edges or moving parts. Damaged or entangled cords increase the risk of electric shock.</p> <p>If operating a power tool in a damp location is unavoidable, use a Ground Fault Circuit Interrupter (GFCI). The use a GFCI reduces the risk of electric shock.</p>
------------------	--

Personal safety

⚠ CAUTION	<p>Stay alert, watch what you are doing and use common sense when operating a power tool. Do not use a power tool while you are tired and/or under the influence of drugs, alcohol or medication. A moment of inattention while operating power tools may result in serious personal injury.</p>
NOTICE	<p>All persons who operate the power tool must have read and fully understood all relevant operating instructions. Misunderstanding may result in personal injury.</p>
⚠ CAUTION	<p>Use personal protective equipment. Always wear eye protection. Protective equipment such as dust mask or hearing protection used for appropriate conditions will reduce personal injuries.</p>
NOTICE	<p>Prevent unintentional starting. Ensure the switch is in the off-position before connecting the power tool to the power source, picking it up or carrying the tool. Carrying power tools with your finger on the switch or energizing power tools that have the switch on invites accidents.</p>
NOTICE	<p>Remove any adjusting key or wrench before turning the power tool on. A wrench or a key left attached to a rotating part of the power tool may result in personal injury.</p>
NOTICE	<p>Do not overreach. Keep proper footing and balance at all times. This enables better control of the power tool in unexpected situations.</p>
NOTICE	<p>Dress properly. Do not wear loose clothing or jewelry. Keep your hair, clothing and gloves away from moving parts. Loose clothes, jewelry or long hair can be caught in moving parts.</p>
⚠ CAUTION	<p>If devices are provided for the connection of dust extraction and collection facilities, ensure these are connected and properly used. Use of dust collection can reduce dust-related hazards.</p>

Power tool use and care

NOTICE	<p>Do not force the power tool. Use the correct power tool for your application. The correct power tool will do the job better and safer at its dedicated rate for which it was designed.</p>
NOTICE	<p>Do not use the power tool if the switch cannot be turned on and/or off. Any power tool that cannot be controlled with the switch is dangerous and must be repaired.</p>
⚠ CAUTION	<p>Disconnect the plug from the power source and/or the battery pack from the power tool before making any adjustments, changing accessories, or storing power tools. Such preventive safety measures reduce the risk of starting the power tool accidentally.</p>
⚠ CAUTION	<p>Store idle power tools out of the reach of children and do not allow persons unfamiliar with the power tool or these instructions to operate the power tool. Power tools are dangerous in the hands of untrained users.</p>
NOTICE	<p>Maintain power tools. Check for misalignment or binding of moving parts, breakage of parts and any other conditions that may affect the power tool's operation. If damaged, have the power tool repaired before use. Many accidents are caused by poorly maintained power tools.</p>
NOTICE	<p>Keep cutting tools sharp and clean. Properly maintained cutting tools with sharp cutting edges are less likely to bind and are easier to control by the machine.</p>
NOTICE	<p>Use the power tool, accessories and end mills etc. in accordance with these instructions, taking into account the working conditions and the work to be performed. Use of the power tool for operations different from those intended could result in a hazardous situation.</p>

Continued on next page

Service

	Have your power tool serviced by a qualified repair person using only identical replacement parts. This will ensure that the safety of the power tool is maintained.
--	---

Safety Rules for Rotary Tools	
⚠ WARNING	Make sure that the power tool cannot cut its own cord, therefore never install the power cord across the machine table. Cutting a "live" wire may shock the operator.
⚠ CAUTION	Use clamps or another practical and secure way to support the workpiece and secure it to the machine table. Holding the workpiece with your hands leaves it unstable and may lead to loss of control.
NOTICE	Accessories must be rated for at least the speed recommended on the tool warning label. Accessories running over rated speed can fly apart and cause injury.
⚠ CAUTION	Always disconnect the power cord from the power source before making any adjustments or attaching any accessories. You may unexpectedly cause the tool to start leading to serious personal injury.
	Be aware of the switch location, when placing the tool down or when picking the tool up. You may accidentally activate the switch.
	Do not hold the Tool Changer in your hands during the start-up. The reaction torque of the motor, as it accelerates to full speed, can cause the shaft to twist.
NOTICE	Always wear safety goggles and dust mask. Use only in well ventilated area. Using personal safety devices and working in safe environment reduces risk of injury.
	After changing the bits or making any adjustments, make sure the ER collet and the clamping nut are both securely tightened. Loose adjustment devices can unexpectedly shift, causing loss of control. Loose rotating components will be violently thrown.
⚠ CAUTION	This is not a handheld tool. The Tool Changer is designed to be system-guided and must be operated in a CNC router or 3D Desktop System. Operation of the power tool handheld may result in serious personal injury.
NOTICE	Do not reach in the area of the spinning bit. The proximity of the spinning bit to your hand may not always be obvious.
NOTICE	Do not operate wire and bristle brushes with the spindle. Bristles or wires will be discharged from the brush at high speeds, can fly apart and cause injury.
	Never use dull or damaged bits. Sharp bits must be handled with care. Damaged bits can snap during use. Dull bits require more force to cut the tool, possibly causing the bit to break.
⚠ CAUTION	Use clamps to support workpiece. Never hold a workpiece with your hands.
	Inspect your workpiece before cutting. For example, if carving wood, make sure there are no nails or foreign objects in the workpiece. Nails or foreign objects can cause the bit to break.
	The speed and feed with the bit into the material when carving, routing or cutting is very important. Always observe the speed and feed for the particular bit recommended.
⚠ CAUTION	If the workpiece or bit becomes jammed or bogged down, turn the power tool "OFF" by the switch. Wait for all moving parts to stop and unplug the tool, then work to free the jammed material. If the switch to the tool is left "ON" the tool could restart unexpectedly causing serious personal injury.
NOTICE	Do not leave a running tool unattended, turn power off. Only when tool comes to a complete stop and is disconnected from the mains is it safe.
⚠ CAUTION	Do not touch the bit or collet after use. After usage bit and collet are too hot to be touched with bare hands.
	Clean the tool's air vents every 4 hours by using compressed air. Excessive accumulation of powdered metal inside the motor housing may cause electrical failures.
NOTICE	Do not allow familiarity gained from frequent use of your rotary tool to become commonplace. Always remember that a careless fraction of a second is sufficient to inflict severe injury.
⚠ CAUTION	Do not alter or misuse tool. Any alteration or modification is a misuse and may result in serious personal injury.
⚠ CAUTION	This product is not intended for use as a dental drill, in human or veterinary medical applications. Serious personal injury may result.

Continued on next page

⚠ CAUTION	When using the end mills, V-bits or cutters, always have the workpiece securely clamped. Never attempt to hold the workpiece with your hands while using any of these accessories. The reason is that these tools will grab if they become slightly canted in the groove, and can kickback causing loss of control resulting in serious injury.
------------------	---

Safety Rules for system-guided Tools











⚠ CAUTION	The Tool Changer needs to be controlled by a control software of a CNC router. Therefore the power supply of the spindle has to be properly connected to the external output of the main board of the CNC router via a 15-pin Sub-D cable. Prior to each commissioning of the power tool the ON/OFF, speed and emergency button functionality has to be checked. Malfunction may result in serious personal injury.
NOTICE	Do not leave a running CNC system and power tool unattended, turn power off. Only when a CNC router or power tool comes to a complete stop and are disconnected from the mains are they safe.

Additional Safety Warnings

	Depending on the application field of the machine (private or commercial), observe the applicable occupational safety and health, safety and accident prevention and environmental regulations, too.
NOTICE	GFCI and personal protection devices like electrician's rubber gloves and footwear will further enhance your personal safety.
⚠ CAUTION	Do not use AC only rated tools with a DC power supply. While the tool may appear to work, the electrical components of the AC rated tool are likely to fail and create a hazard to the operator.
	Develop a periodic maintenance schedule for your tool. When cleaning a tool be careful not to disassemble any portion of the tool. Certain cleaning agents such as gasoline, carbon tetrachloride, ammonia, etc. may damage the surface.
⚠ CAUTION	Risk of injury to user. The power cord must only be served by a STEPCRAFT service facility.
⚠ WARNING	Some dust created by power cutting, routing, milling, drilling, and other construction activities contains chemicals known to cause cancer, birth defects or other reproductive harm. Some examples of these chemicals are: Lead from nonferrous metals with lead content, carbonate from carbon fiber, arsenic and chromium from chemically-treated lumber. Your risk from exposures to these varies, depending on how often you do this type of work. To reduce your exposure to these chemicals: work in a well ventilated area, and work with approved safety equipment, such as those dust masks that are specially designed to filter out microscopic particles.

Symbols

IMPORTANT: Some of the following symbols may be used on your tool. Please study them and learn their meaning. Proper interpretation of these symbols will allow you to operate the tool better and safer.

Symbol	Name	Designation/Explanation
V	Volts	Voltage (potential)
A	Amperes	Current
Hz	Hertz	Frequency (cycles per second)
W	Watt	Power
Kg	Kilograms	Weight
Min	Minutes	Time
S	Seconds	Time
mm	Length, Height, Width	Size in millimeter (metric)
inch	Length, Height, Width	Size in inch
∅	Diameter	Size of drill bits, end mills, etc.
.../min	Revolutions or reciprocation per minute	Revolutions, turns, etc. per minute
V→, V↓	Speed	Horizontal / vertical speed in millimeter per second
0	Display off position	Zero speed / revolution per minute
15, 45, 75, 99	Display selector settings	Speed / revolution per minute as percentage share of the max. speed / revolution. Higher number means greater speed. 99 equals the max. revolution per minute.
→	Arrow	Action in the direction of an arrow
	Warning symbol	Alerts user to warning messages
	CAUTION hot surface	Alerts user not to touch the surface – danger of burns
	CAUTION rotating tool	Alerts user not to touch the blade / the insertion tool - danger of lacerations
	Wear eye protection symbol	Alerts user to wear protective glasses
	Wear hand protection symbol	Alerts user to wear protective gloves
	Grounding symbol	Alerts user to ground the power tool / electrical system
	Wear ear protection symbol	Alerts user to wear a hearing protector
	Read manual symbol	Alerts user to read manual BEFORE first commissioning
	Unplug symbol	Alerts user to unplug the device BEFORE servicing the power tool
	Disposal symbol	Instructions for disposal of WEEE by users of the European Union

CONTENT

1	General Instructions	9
1.1	Information and Explanations to the Operating Instructions.....	9
1.2	Description of Components	9
1.3	Intended Use.....	10
2	Design and Function.....	10
2.1	Designation of the Individual Parts of the Tool Change Attachment	10
2.2	Designation of the Individual Parts of the Tool Magazine	10
2.3	Designation of the Individual Parts of the Control Module (incl. Pneumatic Valve) ..	10
2.4	Designation of the Auxiliary Tools	11
3	Start-up	11
3.1	Mounting the Tool Change Attachment onto the Stepcraft HFS	11
3.2	Inserting the Control Module into the Stepcraft Switch-Box	12
3.3	Pneumatic Connection of the Tool Changer	12
3.4	Electric Connection of the Switch-Box.....	12
3.5	Installation of the Tool Changer on the Stepcraft Desktop 3D System.....	12
3.6	Installation of the Tool Magazine.....	12
3.7	Setup of the Tool Magazine in WinPC-NC.....	13
3.8	Macro Programming in WinPC-NC.....	15
3.8.1	Macro hold tool.....	15
3.8.2	Macro store tool	15
3.9	Test of the Automatic Tool Change Function.....	16
3.10	Environmental Conditions	16
3.11	Optional Accessories.....	17
3.12	Tool Holders SK10.....	17
3.12.1	Tool Magazine.....	17
4	Operation Switch-Box / Tool Change Attachment	17
4.1	Operator.....	17
4.2	Tool Change Attachment / Switch-Box	17
4.3	Emergency-stop Switch.....	18
5	Technical Specifications.....	18
5.1	Dimensions and Weight of the Tool Change Attachment.....	18
5.2	Other Characteristics of the Tool Change Attachment.....	18

6	Transport / Storage	19
6.1	Transport.....	19
6.2	Packaging	19
6.3	Storage	19
7	Maintenance	19
7.1	Service.....	19
7.2	Maintenance Work	19
8	Failures	20
8.1	Response to Malfunctions	20
9	Annex	20
9.1	Warranty and Service Contact Information	20
9.2	Manufacturer	21
9.3	Copyright.....	21
9.4	Limited Warranty	21
9.5	Instructions for disposal of WEEE by users of the European Union.....	23
9.6	RoHS, 2002/95/EC.....	23
9.7	EC-declaration of conformity	23

1 GENERAL INSTRUCTIONS

1.1 INFORMATION AND EXPLANATIONS TO THE OPERATING INSTRUCTIONS

This manual will familiarize you with your STEPCRAFT Tool Change System (hereafter referred to as TCS) and its control system, providing you with all the necessary information you will need in order to operate the device safely and professionally.



Please read this manual thoroughly and carefully prior to the first use of your STEPCRAFT TCS. Operate the machine and the associated control system only when you are sure that you have understood these instructions in their entirety. Hereby you minimize the risk of injury and / or prevent property damage.

Should you encounter any doubts or require any further information, do not hesitate to contact us. Our contact information can be found on the front page of this manual.

Keep this manual always in close proximity to the STEPCRAFT TCS for future reference.

Only apply the components according to their intended use (see point 1.3).

We cannot be held accountable either for any kind of injury and / or property damage resulting from non-intended usage and improper handling deviating from the recommended use of the STEPCRAFT TCS or from failure to follow the safety regulations properly (see page 2).

In case of a lack of maintenance (see point 8) and / or incorrect operation of the individual parts all warranty claims are not-applicable.

We reserve the right to further develop the TCS.

1.2 DESCRIPTION OF COMPONENTS

The STEPCRAFT TCS basically consists of the Tool Change Attachment, the control module incl. the pneumatic valve (suitable for the STEPCRAFT Switch-Box) and the tool holders. The Tool Change Attachment has a 43 mm collar as well as an active sealing air. The milling cutters are clamped using tool holders (similar to SK10) with a direct collet. The side air outlet feeds the pneumatic change function. The lateral shaft lock button allows for a convenient tool change. The ring clamping nut allows for a secure clamping connection to the STEPCRAFT milling spindle.

The delivery scope consists of the following components:

1. Tool Change Attachment, fully assembled
2. Control module incl. pneumatic valve (opt.)
3. 4 m connection hose \varnothing 6 mm
4. 2 x SK10 tool holders with a clamping diameter of 3,175 mm
5. 5-fold tool magazine incl. mounting bases
6. Operating / Safety instructions manual
7. Calibration pin and locking screw
8. Switch-Box (opt.)

For more information on optional accessories, see item 4.9 of this manual.

1.3 INTENDED USE

The STEPCRAFT TCS has been developed for private users (e. g. model designers) and for single or small batch production in the commercial sector. It is not suitable either for large-scale production or for integration into assembly lines. It is designed for the usage of cutters and engraving burins with a diameter up to 6 mm. The system is specifically designed for mounting onto our STEPCRAFT high frequency spindle and the connection to our STEPCRAFT Switch-Box - Plug & Play.

2 DESIGN AND FUNCTION

2.1 DESIGNATION OF THE INDIVIDUAL PARTS OF THE TOOL CHANGE ATTACHMENT

- 1 = Ring clamping nut
- 2 = 43 mm Euro-neck intake
- 3 = Conical holder
- 4 = 43 mm spindle clamping tool
- 5 = Connecting conus
- 6 = Air connection tool change function
- 7 = Tool holder



2.2 DESIGNATION OF THE INDIVIDUAL PARTS OF THE TOOL MAGAZINE

- 1 = Lens head screw M4 x 8
- 2 = Tool magazine (5-fold)
- 3 = Magazine bases

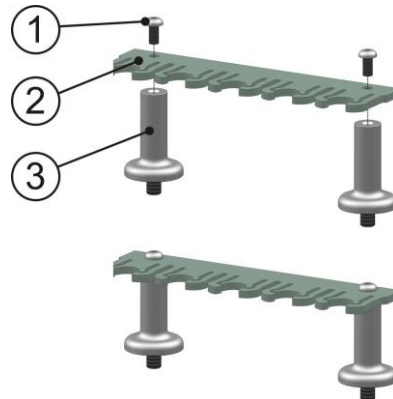

2.3 DESIGNATION OF THE INDIVIDUAL PARTS OF THE CONTROL MODULE (INCL. PNEUMATIC VALVE)

- 1 = Control module (electronic)
- 2 = Holding screw M3x4
- 3 = Bulkhead fitting \varnothing 4 mm
- 4 = Pneumatic valve
- 5 = Hose fitting \varnothing 6 mm
- 6 = Pneumatic hose \varnothing 6 mm

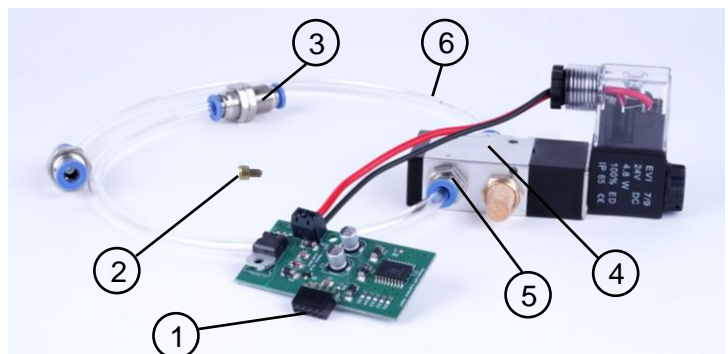

2.4 DESIGNATION OF THE AUXILIARY TOOLS

Calibration pin



Locking screw



3 START-UP

3.1 MOUNTING THE TOOL CHANGE ATTACHMENT ONTO THE STEPCRAFT HFS

For the mounting of the Tool Change Attachment you are in need of the STEPCRAFT HFS 350 or 500, the Tool Change Attachment, the respective operating instructions (OI) and the locking screw.

Preparations of the HFS 350 resp. 500

Unscrew the ER11 collet nut (part 7, point 3.1 OI HFS) from the spindle shaft.

Preparations of the Tool Change Attachment

Unscrew the air connection of the tool change function (part 6, point 2.1). Take the locking screw (point 2.4) and insert it into the now available threaded hole. Turn the spindle shaft until the locking pin is congruent with the locking hole of the spindle shaft. Tighten the locking pin manually. The spindle shaft should not be able to be twisted anymore. Unscrew the ring clamping nut (part 1, see point 2.1) so far for it to be flush with the 8 clamping tongue.

Mounting the Tool Change Attachment onto the spindle

Take the spindle, press and hold the locking pin (part 6, point 3.1, OI STEPCRAFT HFS).

Push the Tool Change Attachment over the 43 mm collar of the spindle and screw the whole device **slightly hand tight** onto the spindle shaft. Afterwards, release the locking pin.

Unscrew the locking pin and insert the air connection for the tool change function again into the threaded hole. The shaft of the Tool Change Attachment incl. the shaft of the spindle should be able to be twisted easily.

Adjust the Tool Change Attachment in a way that the connections are about each other.

Brace both components by tightening (hand tight) the ring clamping nut (part 1, point 2.1).



From now on, this unit will be referred to as the Tool Changer (TC).

You can disassemble the system in the exact reverse order.

3.2 INSERTING THE CONTROL MODULE INTO THE STEPCRAFT SWITCH-BOX

When you have bought both components simultaneously, this task has already been managed by STEPCRAFT. Proceed with point 4.3.

If you have bought these components separately, the assembly has not taken place yet. You can find all the information in the documentation for the STEPCRAFT Switch-Box.

3.3 PNEUMATIC CONNECTION OF THE TOOL CHANGER

The TC is being connected to the air outlet of the STEPCRAFT Switch-Box with the hose enclosed (\varnothing 6 mm). Please hold this hose only as long as needed.

The air inlet of the STEPCRAFT Switch-Box is being connected to the outlet of the compressor. You will find suitable adapters among the accessories (point 3.11). The compressor should supply between 8 and 10 bar compressed air.

3.4 ELECTRIC CONNECTION OF THE SWITCH-BOX

Connect the Switch-Box with the STEPCRAFT Desktop 3D System using the enclosed 15-pin connecting cable.

Connect the Switch-Box with the STEPCRAFT HFS 350 resp. 500 using the enclosed 15-pin connecting cable.

3.5 INSTALLATION OF THE TOOL CHANGER ON THE STEPCRAFT DESKTOP 3D SYSTEM

Insert the clamping surface (part 2, point 2.1) of the TC completely into the \varnothing 43 mm Euro-neck intake of your STEPCRAFT Desktop 3D System. The locating surface of the TC should rest upon the orange Euro-neck collar. Now, clamp the TC by tightening the tensioning screw of the Euro-neck collar.

3.6 INSTALLATION OF THE TOOL MAGAZINE

We recommend the mounting of the magazine at the right rear of the machine in x-orientation.

This position will always be circuited during a reference movement. Thus, it will get the least in the way and the risk of a collision is minimized. It is sufficient for the center of the tool pockets to be barely positioned in the travel range of the y-axis. The following illustration shows the position of the holes (\varnothing 5 with M6 thread), with the dimensioning of the rear and the right, that need to be drilled into the machine table. These dimensions are valid for all sizes of the STEPCRAFT 1 as well as the STEPCRAFT 2 machine series. If you want to attach a second tool magazine (and extend to 10 tool pockets), you can find the respective drill positions in parentheses.

Tip: Drill the holes precisely, only an absolutely plane magazine can be easily setup in the software.

Machine table STEPCRAFT 1 series:

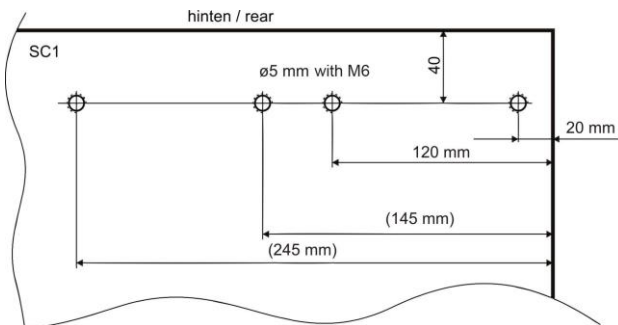

Machine table STEPCRAFT 2 series:

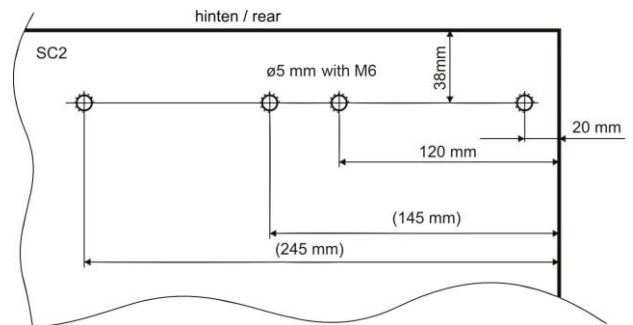

3.7 SETUP OF THE TOOL MAGAZINE IN WINPC-NC

Preparation: Take a tool holder (part 7, point 2.1) and the calibration pin (point 2.4) as an auxiliary tool, Insert this all the way into the tool holder and brace it with a clamping nut.

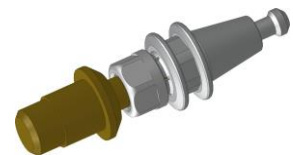

Download the file with the machine parameters „Milling with the Tool Changer“ from our website (Menu_Service & Support_Machine parameters) and save them on your PC.

Get the machine ready for use, start the software and open the suitable parameter file for your machine type and size via the function *Load machine setup* in WinPC-NC. Restart the software and execute a reference movement.

By pressing the manual tool change button (see instruction Switch-Box), the collet is being opened in the interior of the TC. Press the button and clamp the prepared tool holder with the calibration pin into the TC.

Move the calibration pin in the manual mode barely above the tool pocket 1 (far right in the magazine), as shown in the picture.

Move exactly in the position where you can dip into the tool magazine from above without touching it with the smaller diameter of the calibration pin. Move slowly downwards until the greater diameter is barely above the top edge of the magazine (see picture 1, right side).

Correct the x- and y-position in order for the greater diameter to dip into the exact center of the magazine without bending it in any direction.

Move the z-axis downwards until the calibration pin of the magazine touches the locating surface. This position is the measuring position of the tool pocket place 1. Note down the dimensions of the machine coordinates (upper coordinate field in WinPC-NC, move manually) in the lower table.

You can round up the dimensions onto a decimal place. Conduct this step for all future tool pocket places.

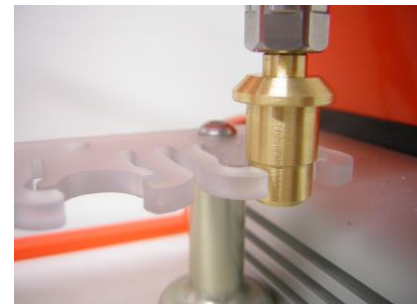

Tool no.	X-coordinate	Y-coordinate	Z-coordinate
1	205,1	207,1	20,7
2	180,1	207,1	20,7
3	155,1	207,1	20,7
4	130,1	207,1	20,7
5	105,1	207,1	20,7

Dimension table for the measuring position of the tool pocket places (with exemplary figures)

Tool no.	X-coordinate	Y-coordinate	Z-coordinate
1			
2			
3			
4			
5			

Transfer the machine coordinates into the next table with the dimensions for the position of the automatic tool change.

For this purpose proceed as follows:

1. Transfer the values of the x-coordinates 1:1 into the column of the x-position.
2. The values of the y-position are calculated based on this formula:

$$\text{Y-coordinate} - 15 = \text{Y-position}$$
3. Transfer the values of the z-coordinates 1:1 into the column of the z-position.

Tool no.	X-position	Y-position	Z-position
1	205,1	192,1	20,7
2	180,1	192,1	20,7
3	155,1	192,1	20,7
4	130,1	192,1	20,7
5	105,1	192,1	20,7

Dimension table for the position for the of the automatic tool change (with exemplary figures)

Tool no.	X-position	Y-position	Z-position
1			
2			
3			
4			
5			

Enter the determined values into the software:

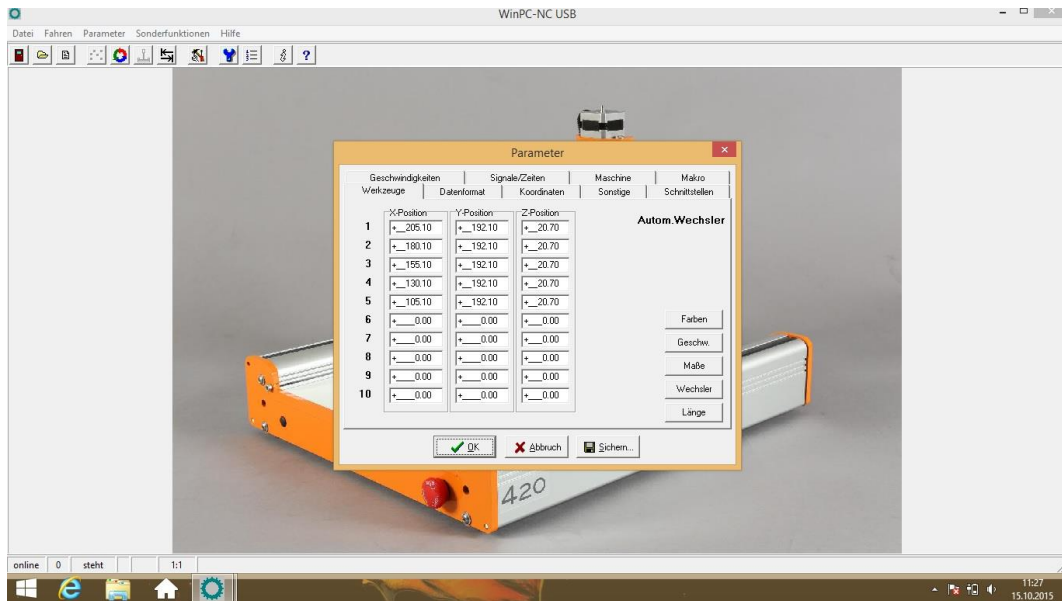

3.8 MACRO PROGRAMMING IN WINPC-NC

In WinPC-NC many complex functions can be controlled with the help of macros. For the TC they are preprogrammed for a magazine that is arranged along the x-axis. These can be modified for other magazine positions by changing the x- and y-commands.

The following macros are already deposited.

3.8.1 MACRO HOLD TOOL

- Speed 25.000 (Machine travels the following commands with 25 mm / second)
- MoveY 15.000 (Spindle moves 15 mm backwards, above the tool holder)
- MoletteOpen (Collet opens)
- MoveZ 20.000 (Spindle moves 20 mm downwards above the tool change holder)
- MoletteClose (Collet closes, tool holder is being tensioned)
- Speed 10.000 (Machine travels the following commands with 10 mm / second)
- MoveY -15.000 (Spindle moves 15 mm upwards and pulls the tool holder out of the magazine)
- Speed 25.000 (Machine travels the following commands with 25 mm / second)
- MoveZ -20.000 (Spindle moves 20 mm upwards into the original position)

3.8.2 MACRO STORE TOOL

- Speed 25.000 (Machine travels the following commands with 25 mm / second)
- MoveZ 20.000 (Spindle moves 20 mm downwards, in front of the tool magazine)
- Speed 10.000 (Machine travels the following commands with 10 mm / second)
- MoveY 15.000 (Spindle moves 15 mm backwards and inserts the tool holder into the magazine)

- MoletteOpen (Collet opens, tool holder is being released)
- Speed 25.000 (Machine travels the following commands with 25 mm /second)
- MoveZ -20.000 (Spindle moves 20 mm upwards above the tool holder)
- MoletteClose (Collet closes)
- MoveY -15.000 (Spindle moves 15 mm forwards into the original position)

3.9 TEST OF THE AUTOMATIC TOOL CHANGE FUNCTION

The machine should be ready-to-use and the TC should be supplied with compressed air. The spindle should be located in approx. the middle of the x- and y-axis in order for the magazine to be traveled to from the front.

Insert one tool holder each into the tool pockets 1 and 2; there should be **no** tool clamped in the TC. Open the menu **Move_Select tool** in WinPC-NC.

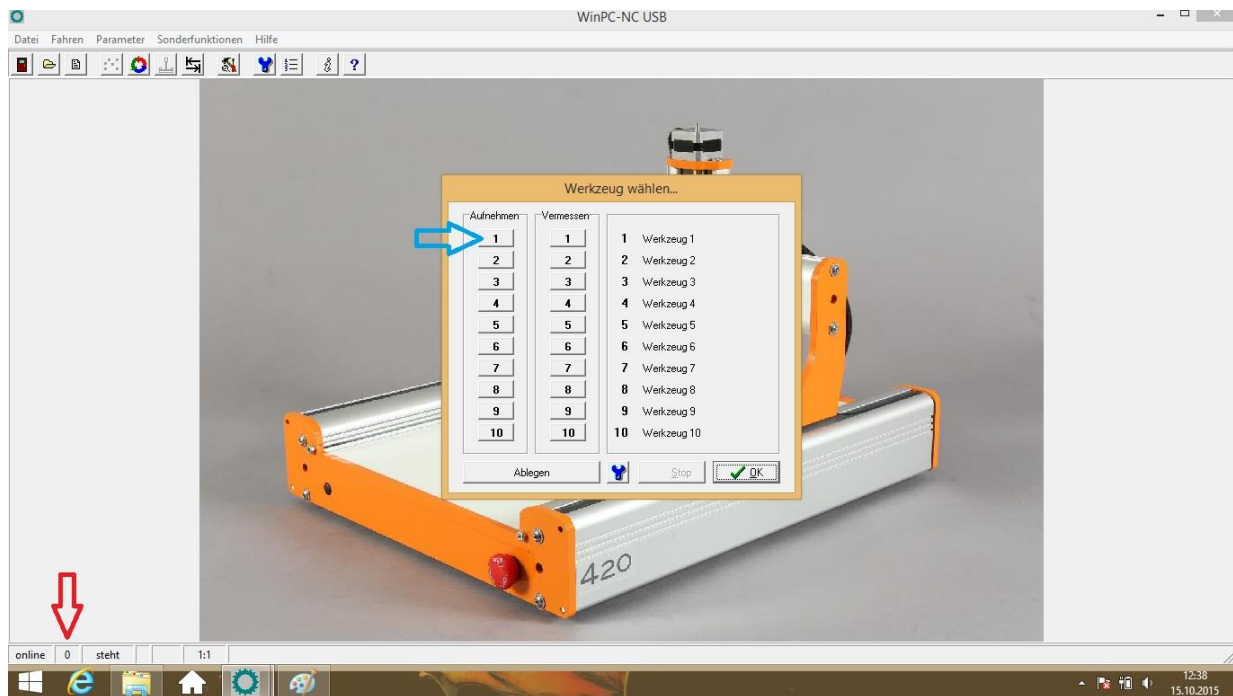

The active tool (red arrow) is shown at the bottom left of the screen. Because no tool is clamped in the spindle right now, it shows 0. Take care that the shown tool is also clamped into the TC before starting each job.

Press 1 in the hold tool column (see blue arrow). The TC should now automatically take up tool 1 (left rear).

Press 2 in the store tool column. The TC should now automatically store tool 1 and take up tool 2.

3.10 ENVIRONMENTAL CONDITIONS

Only setup and operate the TC in indoor environments.

The air surrounding the TC is to be kept low-dust. An excessive exposure to dust may cause damage to the TC.

Humidity should be within the usual levels for indoor environments. Protect the TC against moisture and humidity.

The ideal temperature of the system is between 18°C and 25°C.

Especially protect the electronics from overheating by avoiding exposure of the TC as well as the Switch-Box to direct sunlight or close proximity to a heater.

3.11 OPTIONAL ACCESSORIES

Should you use accessories not manufactured or resold by STEPCRAFT, you need to make sure that it is compatible with your machine.

Please contact the respective manufacturer in case you encounter any doubts.

3.12 TOOL HOLDERS SK10

Please take into consideration that the TC, the STEPCRAFT HFS as well as the machine can be easily overcharged when working with great milling cutters. Use adjusted feed and infeed rates. Please take in mind that greater tools, which are not being precision-balanced, can lead to strong vibrations.

The following tool holders are available:

SK10 tool holder with 3,175 mm inside diameter

SK10 tool holder with 6,0 mm inside diameter

3.12.1 TOOL MAGAZINE

The enclosed magazine can always be extended by 5 magazine pockets. The dimensions of the mounting holes can be gleaned from the illustration (see point 3.6)

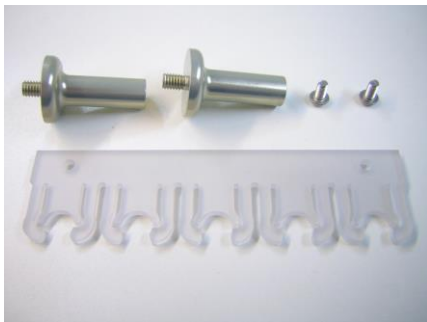

Magazine 5-fold incl. 2x magazine bases and 2x M4x8 fastening screw.

4 OPERATION SWITCH-BOX / TOOL CHANGE ATTACHMENT

4.1 OPERATOR

The improper operation of the Tool changing system can cause serious injury and / or property damage.

Read and observe the major accident prevention regulations!

Each user must have read and understood the all available instructions for the entire system (machine, system-held tool, control and software) before proceeding to operate the device for the first time.

4.2 TOOL CHANGE ATTACHMENT / SWITCH-BOX

⚠ WARNING Never touch the tool! There exists a serious risk of injury!

In order to change a tool holder manually, press the tool change button on the Switch-Box and extract the tool holder.

The tools are clamped without any additional collets into the tool holders. Use two 10 mm open-end wrenches for this purpose.

4.3 EMERGENCY-STOP SWITCH

The emergency-stop switch is located on the front of the STEPCRAFT Desktop 3D System.

Pressing the emergency button leads to an emergency stop of the machine. The machine will stop immediately.

Actuate the emergency stop switch only in emergency situations!

NOTICE: Actuating the emergency stop will result in immediate machine shutdown and can cause step and data losses.

Controlled cessation of the machine's operation can only be effectuated via the control software.

To cancel the emergency stop status, turn the emergency stop switch to the right. Then the control is re-enabled. The work process must be restarted.

The entire system is controlled and operated by the PC.

⚠ CAUTION Prior to first usage, read the manual of your control software thoroughly and carefully, making sure that you have understood everything.



For questions regarding the control software, please contact the respective software developer.

5 TECHNICAL SPECIFICATIONS

5.1 DIMENSIONS AND WEIGHT OF THE TOOL CHANGE ATTACHMENT

Length	=	80 mm
Diameter	=	54 mm
Weight	=	0,36 kg
Clamping neck	=	43 mm (Euro neck)

5.2 OTHER CHARACTERISTICS OF THE TOOL CHANGE ATTACHMENT

Holding system	=	SK10 (STEP CRAFT design)
Collets	=	Integrated collet system
Operating pressure	=	8-10 bar
Sealing air	=	Integrated sealing air ventilation
Max. rotational speed	=	20.000 rpm
True-running accuracy	=	0,02 mm out of the center

Housing = Aluminum 7075, anodized

6 TRANSPORT / STORAGE

6.1 TRANSPORT

Please make sure that the TC is not exposed to heavy shocks during transport. This can lead to unwanted vibrations. If necessary, transport the device in suitable containers.

6.2 PACKAGING

If you do not want to re-use the packaging material of the TC, remove it properly and according to disposal conditions at the site and carry it to the recycling or disposal unit.

6.3 STORAGE

In case of prolonged downtime of the TC and the Switch-Box please observe the following storage conditions:

- Store the device and its components in an indoor environment.
- Protect from moisture, humidity, cold, heat and direct sunlight.
- Store in a dust-free environment, cover if necessary.
- The storage site should be free of any vibrations.

7 MAINTENANCE

7.1 SERVICE

To ensure continued enjoyment of your STEPCRAFT Tool Changing System, handle it carefully. Regular maintenance positively affects the life expectancy of the device.

⚠ WARNING Preventive maintenance performed by unauthorized personnel may cause serious hazard. We recommend that all tool service be performed by a STEPCRAFT service facility.

⚠ WARNING To avoid injury from unexpected starting or electrical shock, always remove plug from wall outlet before performing service or cleaning.



7.2 MAINTENANCE WORK

⚠ WARNING To avoid accidents always disconnect the tool from the power supply before cleaning or performing any maintenance. The tool may be cleaned most effectively with compressed dry air. Always wear safety goggles when cleaning tools with compressed air.



Please conduct the following maintenance operations on a regular basis:

- Clean the collet cone with a soft cloth.
- Take care that no chips as well as the least amount of dust finds its way into the ventilation system.

⚠ CAUTION Certain cleaning agents and solvents damage plastic parts and/or the coating. Some of these are: gasoline, carbon tetrachloride, chlorinated cleaning solvents, ammonia and household detergents that contain ammonia.

⚠ CAUTION To continue using the tool in unmaintained condition will permanently damage your tool.

8 FAILURES

8.1 RESPONSE TO MALFUNCTIONS

⚠ CAUTION If a failure occurs on the device that could cause personal injury or property damage, stop the operation immediately using the emergency-stop switch!

NOTICE: For less serious malfunctions, stop the machine / device normally using the controller. If you cannot fix the malfunction yourself, please contact us, specifying the fault which has occurred.

Our contact details can be found on the front page of this manual.

9 ANNEX

9.1 WARRANTY AND SERVICE CONTACT INFORMATION

Country of Purchase	STEPCRAFT	Address	Phone no. / E-mail address
United States of America	STEPCRAFT Inc.	733 E Main St. Unit 3 Torrington, CT, 06790	+1 203 556 1856 info@stepcraft.us
Germany	STEPCRAFT GmbH & Co. KG	An der Beile 2 58708 Menden Germany	+49 2373 179 11 60 info@stepcraft-systems.com
Rest of the world	Local distributor	see https://www.stepcraft-systems.com/en/retail	see https://www.stepcraft-systems.com/en/retail
	STEPCRAFT GmbH & Co. KG	An der Beile 2 58708 Menden Germany	+49 2373 179 11 60 info@stepcraft-systems.com

9.2 MANUFACTURER

STEEPCRAFT GmbH & Co. KG

An der Beile 2

58708 Menden

Germany

Phone: +49 (0) 2373 – 179 11 60

E-mail: info@stepcraft-systems.com

Website: www.stepcraft-systems.com

9.3 COPYRIGHT

The contents of these operating instructions are the intellectual property of the STEPCRAFT GmbH & Co. KG. Forwarding or copying (also in excerpts) is not allowed without our explicit an written authorization. Any infringements are prosecuted.

9.4 LIMITED WARRANTY

What this warranty covers

STEEPCRAFT GmbH & Co. KG (“STEEPCRAFT”) warrants to the original purchaser that the product purchased (the “product”) will be free from defects in materials and workmanship at the date of purchase.

What is not being covered

This warranty is not transferable and does not cover (i) cosmetic damage, (ii) damage due to acts of God, accident, misuse, abuse, negligence, commercial or improper use, installation, operation or maintenance, (iii) modification of or to any part of the product, (iv) attempted service by anyone other than a STEPCRAFT authorized service center, (v) products not purchased from an authorized STEPCRAFT dealer, or (vi) products not compliant with applicable technical regulations.

OTHER THAN THE EXPRESS WARRANTY ABOVE, STEPCRAFT MAKES NO OTHER WARRANTY OR REPRESENTATION AND HEREBY DISCLAIMS ANY IMPLIED WARRANTIES, INCLUDING, WITHOUT LIMITATION, THE IMPLIED WARRANTIES OF NON-INFRINGEMENT, MERCHANTABILITY AND FITNESS FOR A PARTICULAR PURPOSE. THE PURCHASER ACKNOWLEDGES THAT HE ALONE HAS DETERMINED THAT THE PRODUCT WILL SUITABLY MEET THE REQUIREMENTS OF THE PURCHASER’S INTENDED USE.

Purchaser’s remedy

STEEPCRAFT’s sole obligation and purchaser’s sole and exclusive remedy shall be that STEPCRAFT will, at its option, either (i) service, or (ii) replace any product determined by STEPCRAFT to be defective. STEPCRAFT reserves the right to inspect any and all product(s) involved in a warranty claim.

SERVICE OR REPLACEMENT AS PROVIDED UNDER THIS WARRANTY IS THE PURCHASER’S SOLE AND EXCLUSIVE REMEDY.

Limitation of liability

STEEPCRAFT SHALL NOT BE LIABLE FOR SPECIAL, INCIDENTAL OR CONSEQUENTIAL DAMAGES, LOSS OF PROFITS OR PRODUCTION OR COMMERCIAL LOSS IN ANY WAY, REGARDLESS OF WHETHER SUCH CLAIM IS BASED IN CONTRACT, WARRANTY, TORT, NEGLIGENCE, STRICT LIABILITY OR ANY OTHER THEORY OF LIABILITY, EVEN IF STEPCRAFT HAS BEEN ADVISED OF THE POSSIBILITY OF SUCH DAMAGES. Further, in no event shall the

liability of STEPCRAFT exceed the individual price of the product on which liability is asserted. As STEPCRAFT has no control over usage, setup, final assembly, modification or misuse, no liability shall be assumed or accepted for any resulting damage or injury. By the act of use, setup or assembly, the user accepts all resulting liability. If you as the purchaser or user are not prepared to accept the liability associated with the use of the product, the purchaser is advised to return the product immediately in new and unused condition and in original packaging to the place of purchase.

Law

These terms are governed by German law (without regard to conflict of law principals).

This warranty gives you specific legal rights additional to other rights you may have. STEPCRAFT reserves the right to change or modify this warranty at any time without notice.

Warranty services

Questions, assistance, and service

Your local STEPCRAFT store and / or place of purchase cannot provide warranty support or service. Once assembly, setup or usage of the products has been started, you must contact your local distributor or STEPCRAFT directly. This will enable STEPCRAFT to better answer your question and help you in the event that you may need any assistance. For questions or assistance, please visit our website or call us in order to speak to a product support representative (see contact details 9.1).

Inspection or services

If this product needs to be inspected or serviced and is compliant in the country you live and use the product, please use the STEPCRAFT online service request submission process found on our website or call STEPCRAFT. Pack the product securely using a shipping carton. Please note that original boxes may be included but are not designed to withstand the rigors of shipping without additional protection. Ship via a carrier that provides tracking and insurance for lost or damaged parcels, as STEPCRAFT is not responsible for merchandise unit it arrives and is accepted at our facility. When calling STEPCRAFT, you will be asked to provide your complete name, street address, e-mail address and phone number where you can be reached during business hours. When sending products to STEPCRAFT, please include your contact details and a list of the items included as well as a brief summary of the problem. A copy of your original sales receipt must be included for warranty consideration. Be sure your name and address are clearly written on the outside of the shipping carton.

Warranty requirements

For warranty consideration, you must include your original sales receipt verifying the proof-of-purchase date. Provide warranty conditions have been met, your product will be serviced or replaced free of charge. Service or replacement decisions are at the sole discretion of STEPCRAFT.

NON-warranty service

Should your service not be covered by warranty, service will be completed and payment will be required without notification or estimate of the expense unless the expense exceeds 50% of the retail purchase cost. By submitting the item for service you are agreeing to payment of the service without notification. Service estimates are available upon request. You must include this request with your items submitted for service. Non-warranty service estimates will be billed a minimum of ½ hour of labor. In addition you will be billed for return freight. STEPCRAFT accepts money orders, cashier's checks as well as credit cards and PayPal payment. By submitting any item to STEPCRAFT for service, you are agreeing to STEPCRAFT's Terms and Conditions found on our website (see contact details on front page).

ATTENTION: As manufacturer, the headquarters of STEPCRAFT is qualified to service all products. The sales and service facilities of the different countries are only allowed to service products out of their respective country and products that are compliant with this country. STEPCRAFT service is only available for the owner of the respective product. If received, a non-compliant product will not be serviced. Further, the sender will be responsible for arranging return shipment of the unserviced product

through a carrier of the sender's choice and at the sender's expense. STEPCRAFT will hold non-compliant product for a period of 60 days from notification after which it will be discarded.

9.5 INSTRUCTIONS FOR DISPOSAL OF WEEE BY USERS OF THE EUROPEAN UNION

	<p>This product must not be disposed of with other waste. Instead, it's the user's responsibility to dispose of their waste equipment by handing it over to a designated collection point for the recycling of waste of electrical and electronic equipment. The separate collection and recycling of your waste equipment at the time of disposal will help to conserve natural resources and ensures that it is recycled in a manner that protects human health and the environment. For more information about where you can drop off your waste equipment for recycling, please contact your local office, your house-hold waste disposal or where you purchased your product.</p>
---	--

9.6 RoHS, 2002/95/EC

We confirm that the STEPCRAFT Tool Change Attachment and the STEPCRAFT Switch-Box comply with the RoHS, 2002/95/EC.

9.7 EC DECLARATION OF CONFORMITY

EC manufacturer's declaration of conformity

in terms of the directive 2006/42/EC, appendix II part 1 A

Manufacturer:	Stepcraft GmbH & Co. KG An der Beile 2 58708 Menden Germany
Type of product:	STEPCRAFT Tool Change Attachment
Type designation:	Tool Change Attachment

Hereby we declare, that the device named above is consistent with the following relevant regulations:

- EC machinery directive 2006/42/EC

Representative for the compilation of the technical documentation is the signatory of this declaration.

This declaration becomes void, if not authorized modifications are made to the device.

This EC manufacturer's declaration of conformity was issued

in: Menden
on: 07-22-2016

by:



Peter Urban
(Managing director)



Markus Wedel
(Managing director)

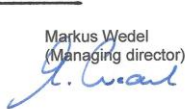

EC manufacturer's declaration of conformity

in terms of the directive 2006/42/EC, appendix II part 1 A

Manufacturer: Stepcraft GmbH & Co. KG
An der Beile 2
58708 Menden
Germany

Type of product: STEPCRAFT Switch-Box

Type designation: Switch-Box

Hereby we declare, that the machine named above is consistent with the following relevant regulations:

- EC machinery directive 2006/42/EC
- EC EMC directive 2004/108/EC
- The machine observes the protection targets of the EC low voltage directive (LVD) 2006/95/EC.

Applied harmonized standards, whose references have been published in the Official Journal of the European Communities:

EN 61029-1 11/2010 Safety of transportable motor-operated electric tools,
Part 1: General requirements

Representative for the compilation of the technical documentation is the signatory of this declaration.

This declaration becomes void, if not authorized modifications are made to the machine.

This EC manufacturer's declaration of conformity was issued

in: Menden
on: 07-22-2016

by:

Peter Hübner
(Managing director)

Markus Wedel
(Managing director)

STPCRAFT.
Stepcraft GmbH & Co. KG
An der Beile 2
D-58708 Menden
Tel +49 (0) 2373 179 11 60
www.stepcraft.de